

PIAWO TERRA

1

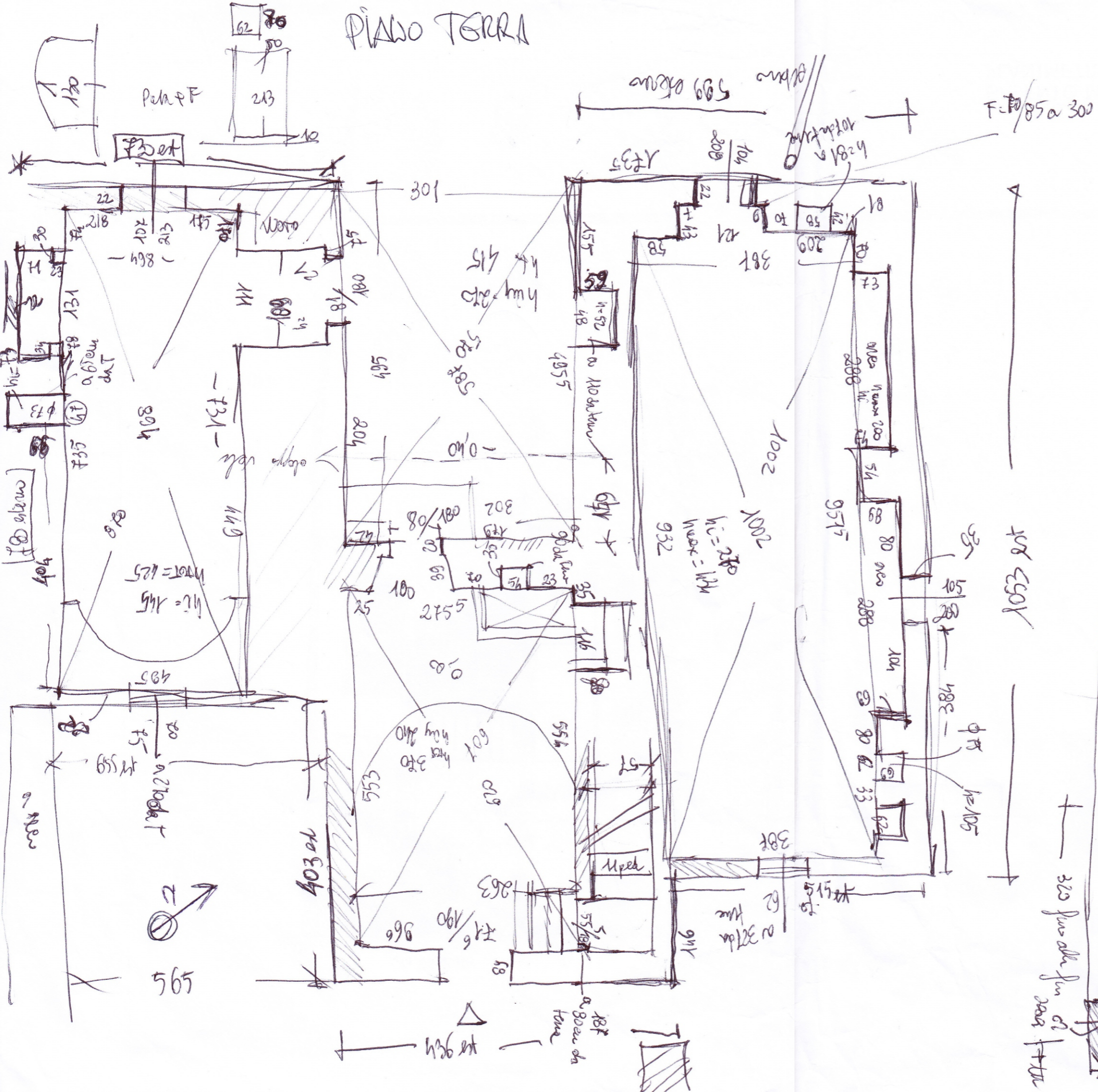

10 PIAWO

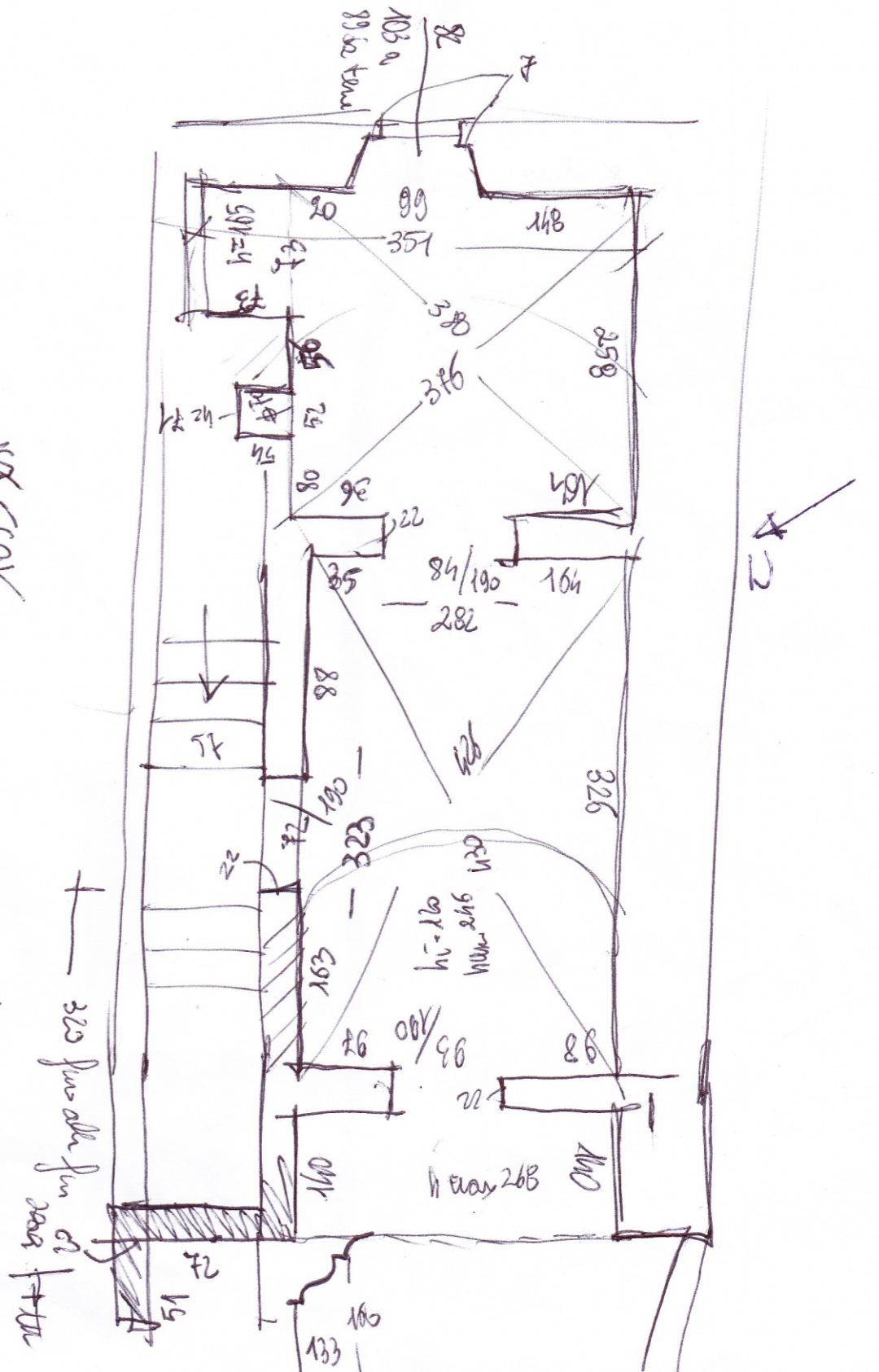

FABBRICAN

VALLO CROLLATO SU STRADA

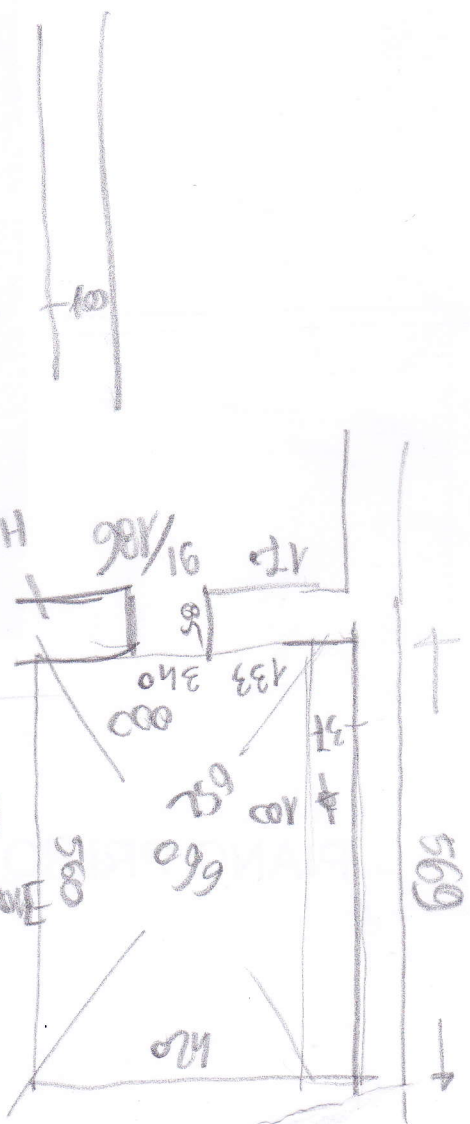
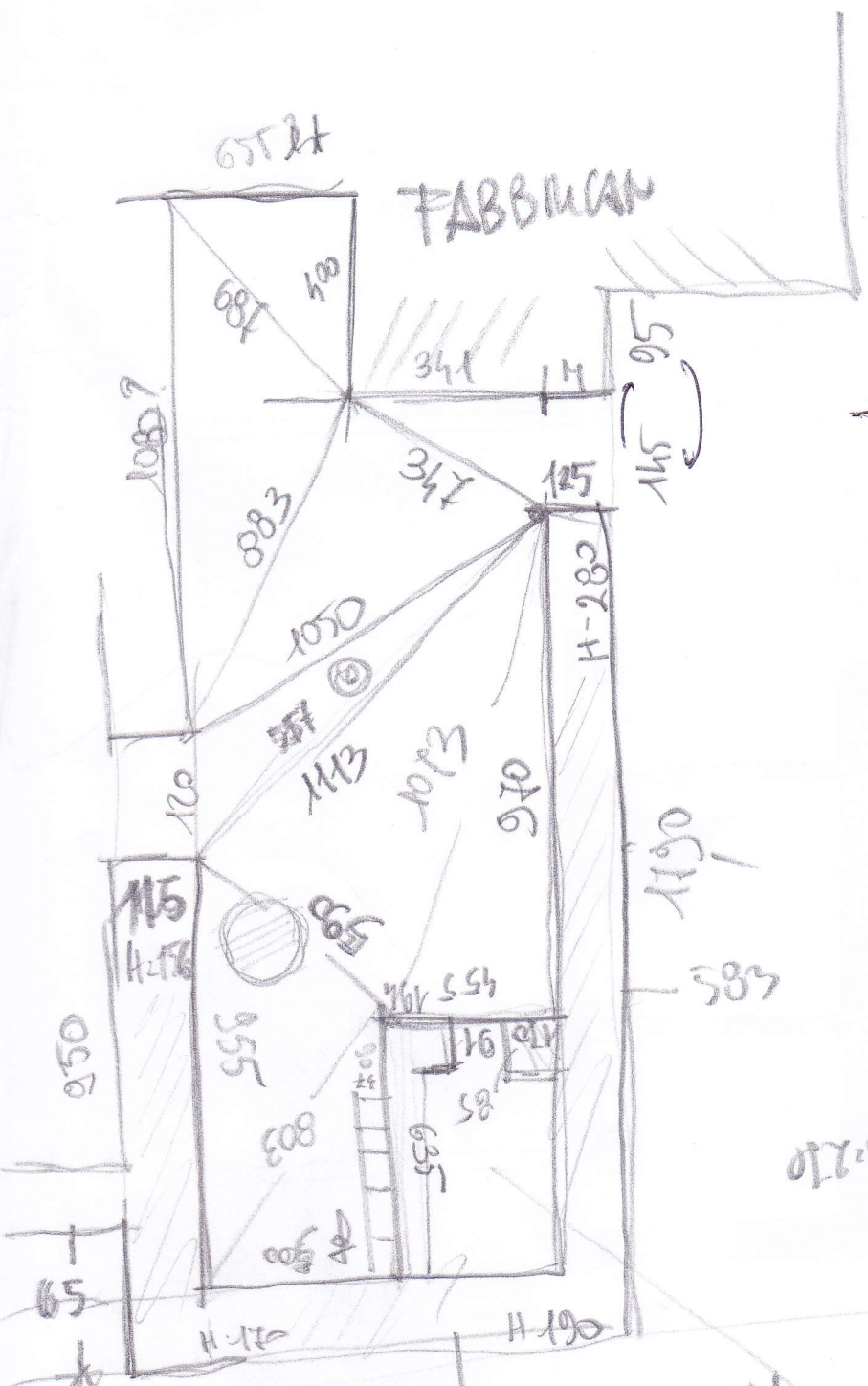

←
partenza
a 15 m

12,15

390 strada

↑ N ↓
PARTICOLARE

569

Persegi panjang
 insulasi = 20
 $H = 275$

125×60

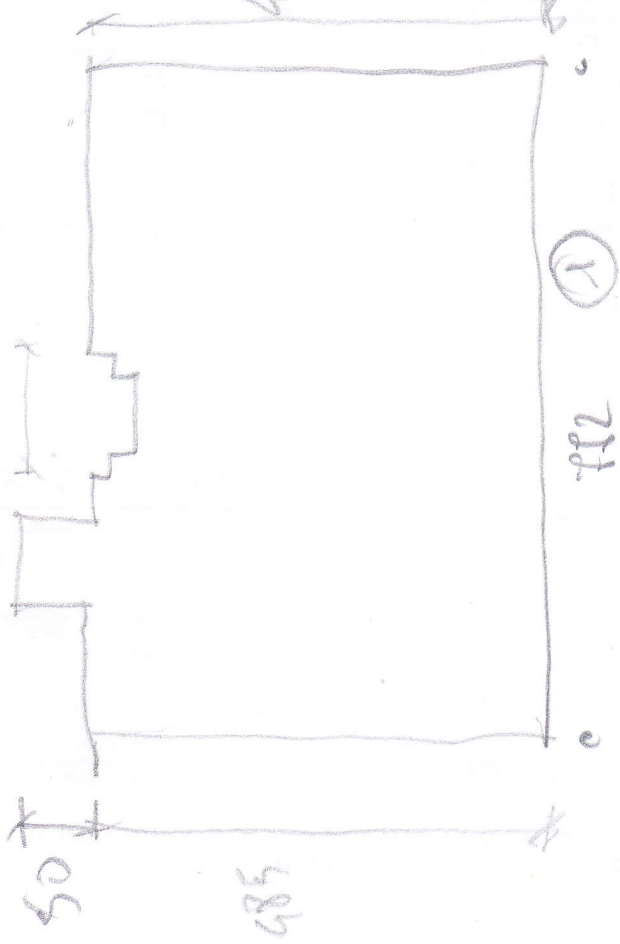

PROSEKSI VAMU (3)

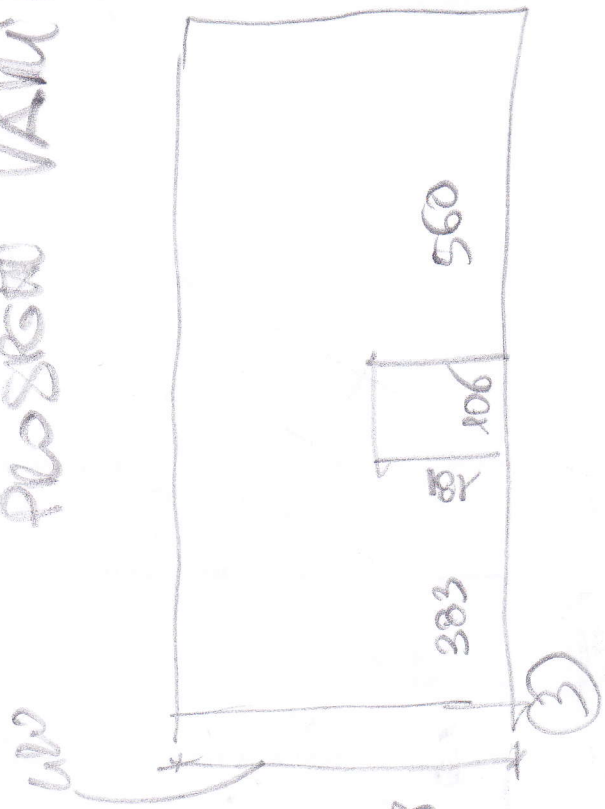

$H \text{ PARAMETRO} = 50$

$H = 470$

150×260



Piano Pav. 1° Piano = 438 misura od. interno

4

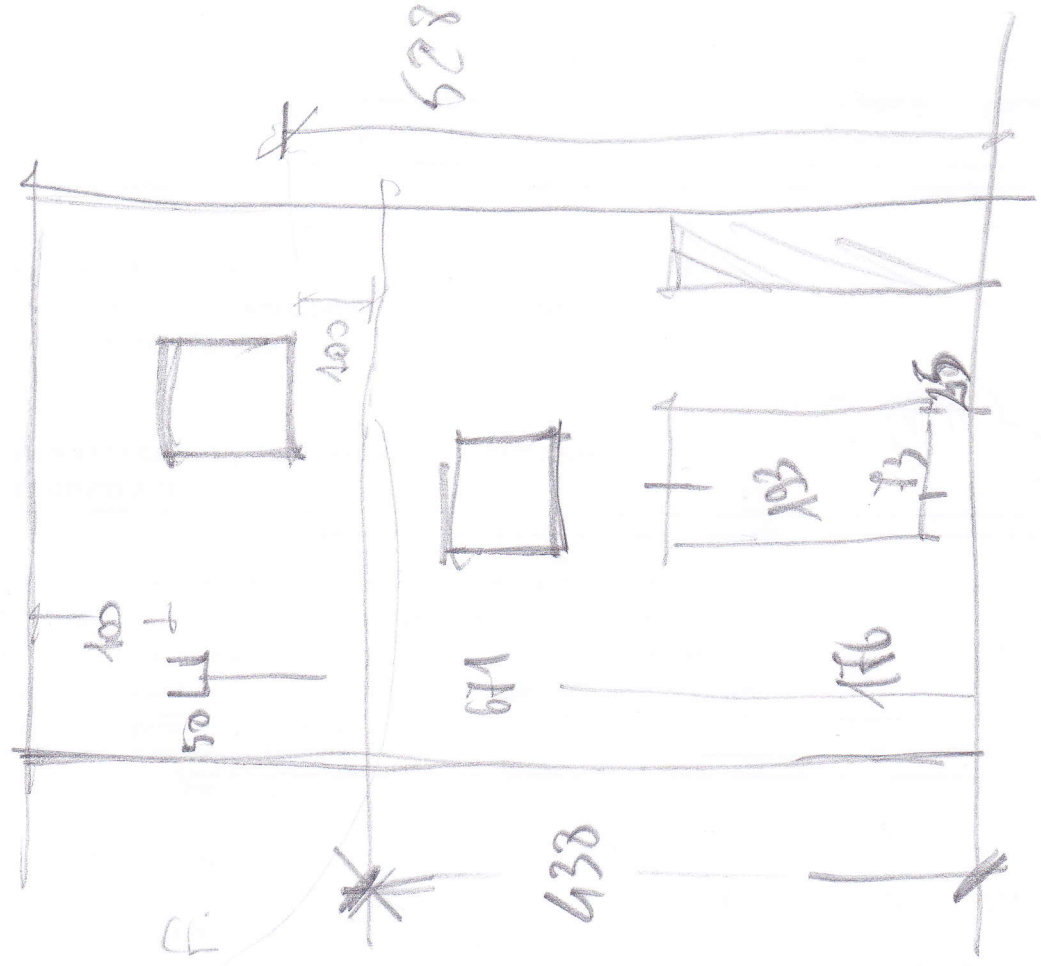

PROSEGNO SUD

ST
*

230
425
101 78

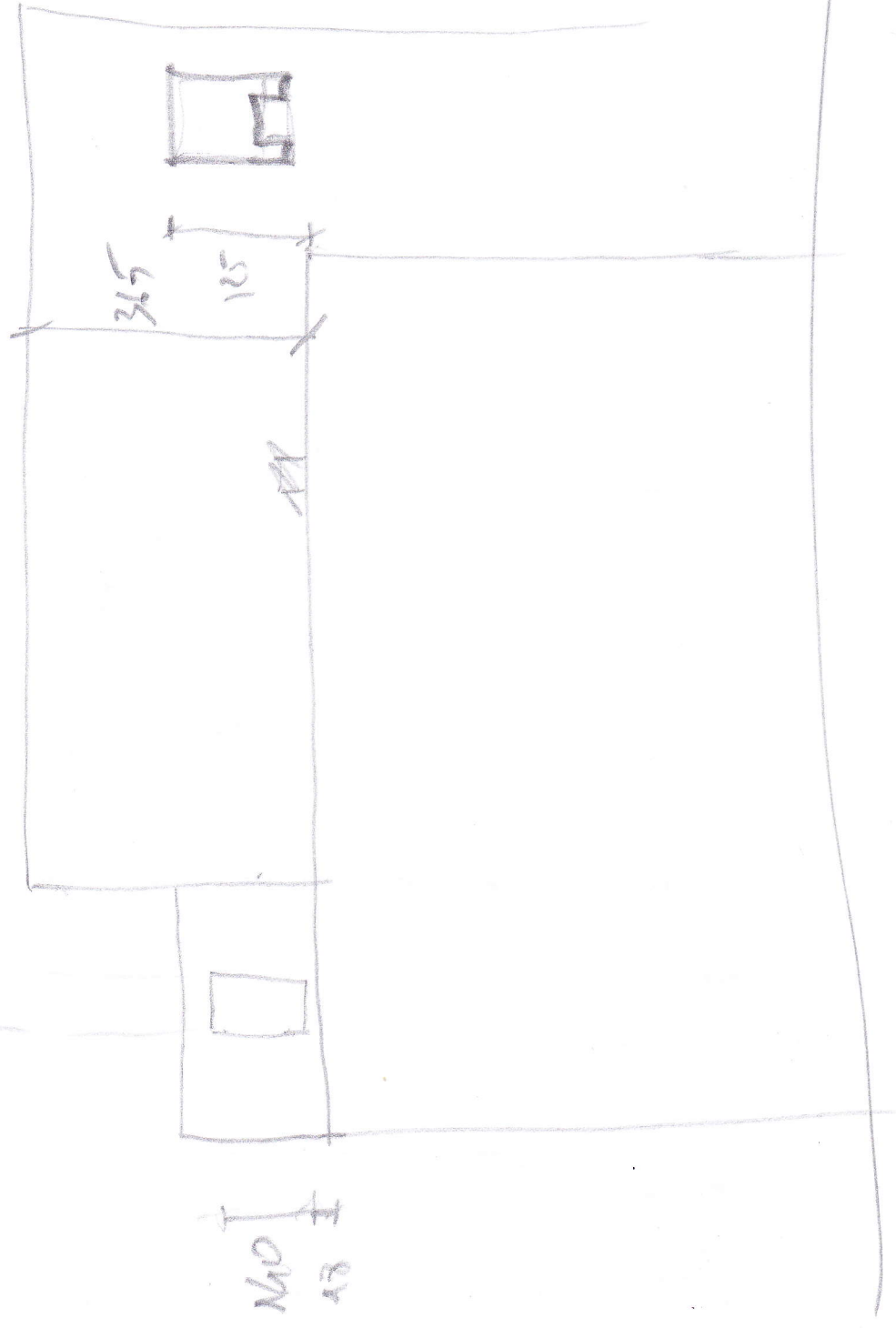

125
125

PROSPECTOR

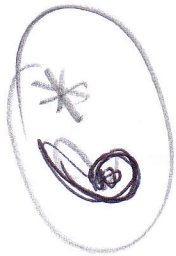

PROJECTIONS

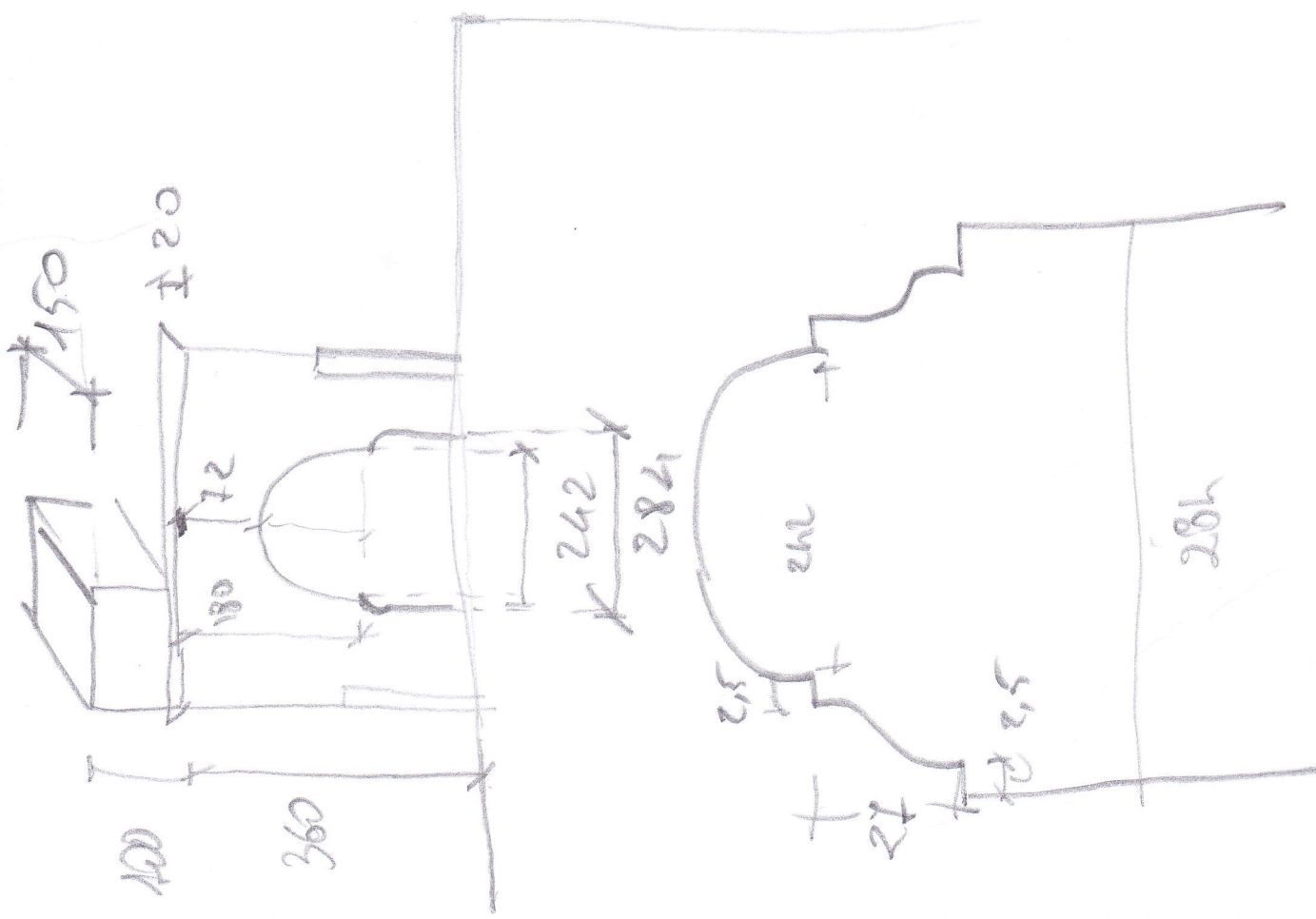

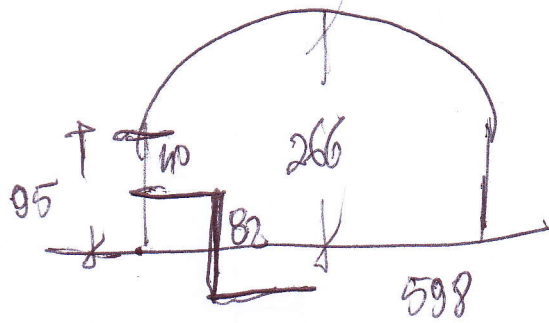

PALMISTO

7

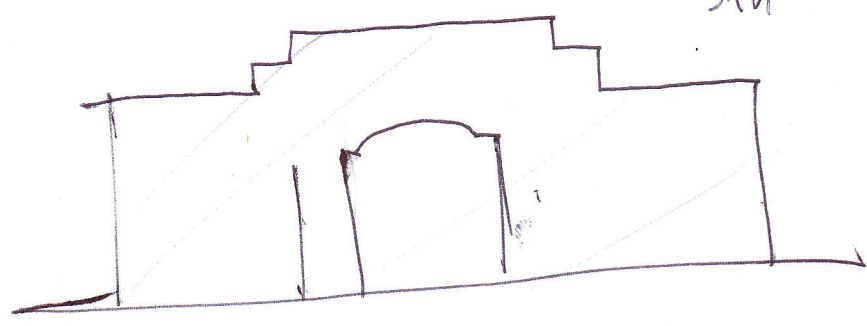
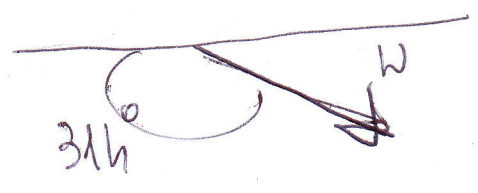
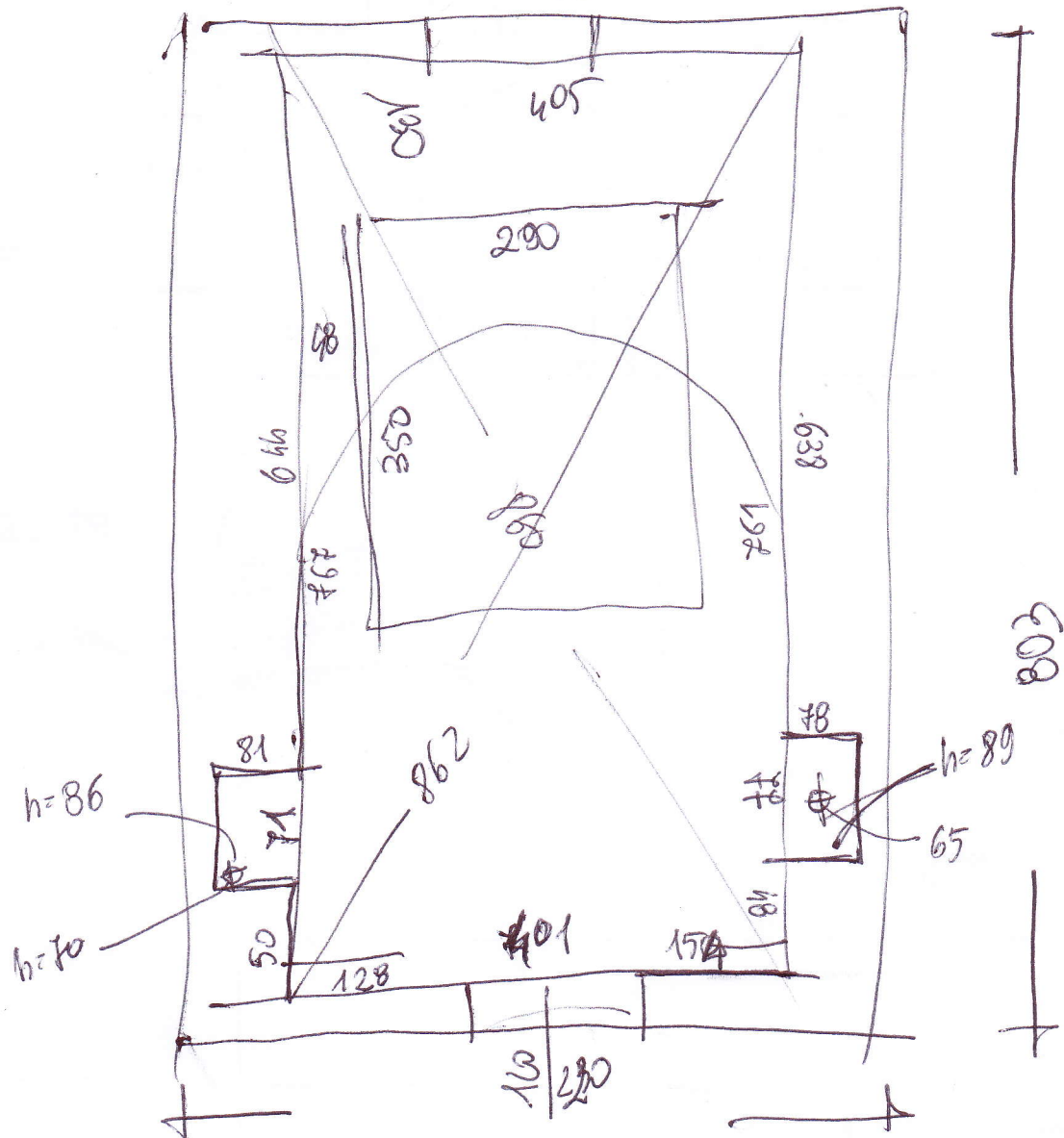

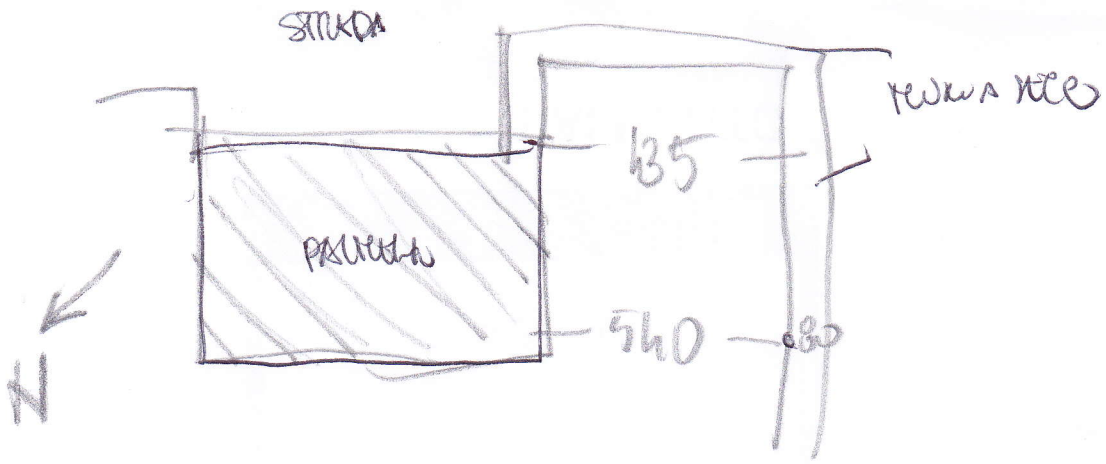

8

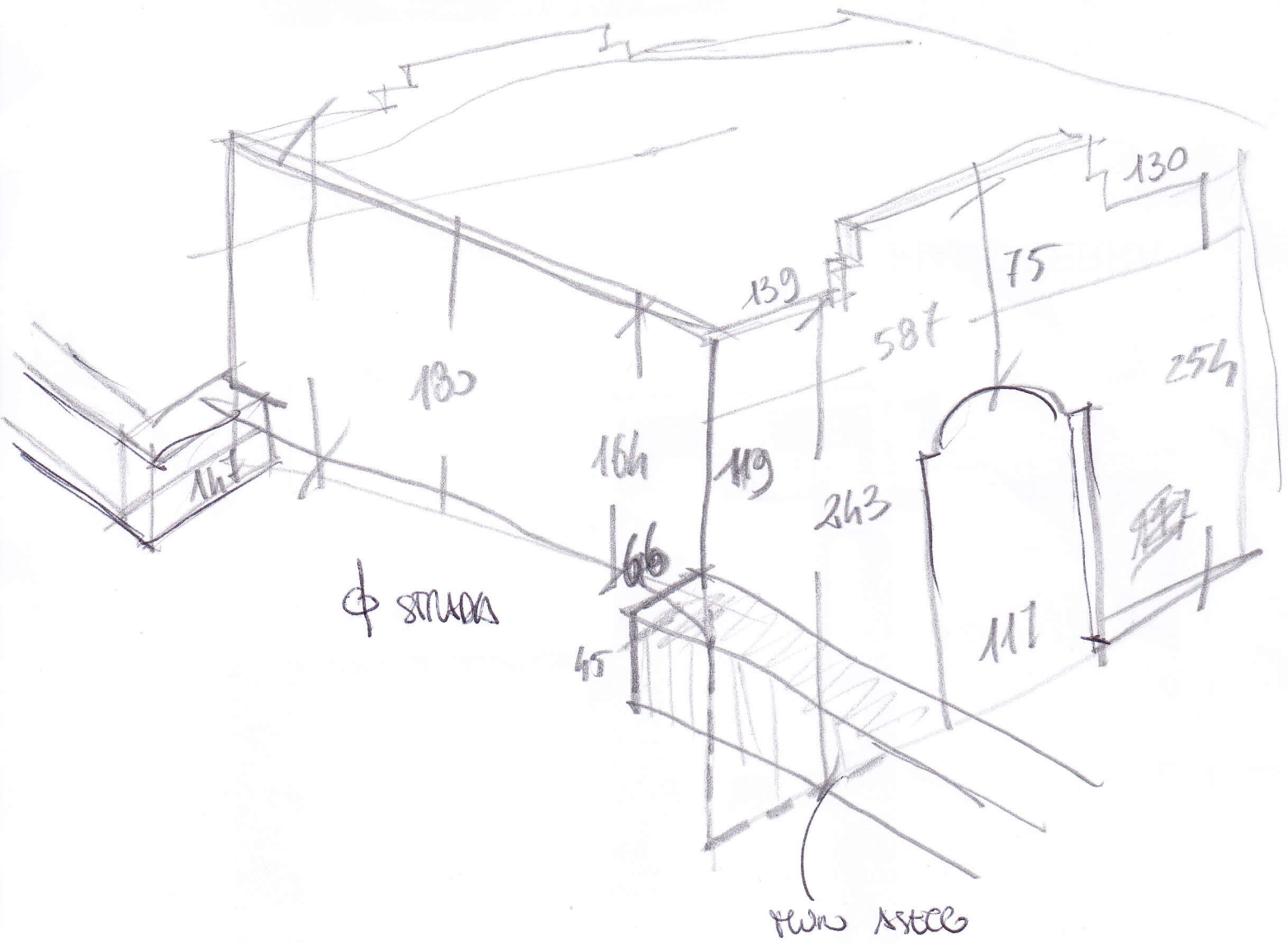

PALUWENTU